

Wall Mounted Touch Panel



- Touch panel 1-5 color RF remote.
- Each Touch panel can remote control multiple RF 2.4G LED controllers.
- Ultra sensitive high strength glass touch panel with touch color wheel in the middle.
- Touch keys with LED indicator.
- Free installation, no wiring, removable.
- CR2032 battery powered.
- White & Black available.



Technical Parameters

Input and Output		Safety and EMC		Environment	
Output signal	RF(2.4GHz)	EMC standard	EN IEC 55015/EN IEC 61547 ETSI EN 301 489-1/-3	Operation temperature	Ta: -30°C ~ +55°C
Working voltage	3VDC(CR2032)	Safety standard	EN 61347-1/-2 EN 62493	Case temperature (Max.)	Tc: +65°C
Working current	<8mA	Radio Equipment	ETSI EN 300 440	IP rating	IP20
Standby current	<16µA	Certification	CE RoHS	Package	
Standby time	1 year	Warranty	5 years	Size	L100 x W92 x H16.5mm
Remote distance	30m (Barrier-free space)			Gross weight	0.137kg

Mechanical Structures and Installations

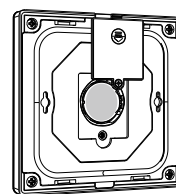
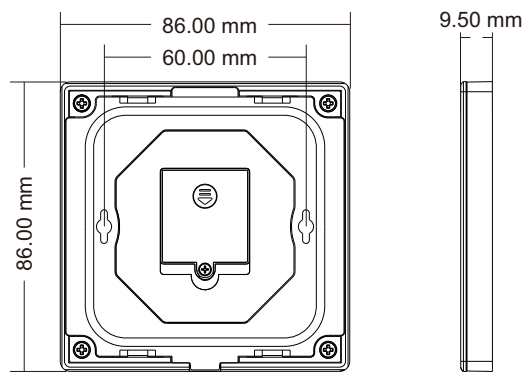

Note:

1. Before the first use, please remove the protective film on the battery.
2. Open the battery cover with a screwdriver.
3. If the LED indicator is not on when press key, it is due to dead battery or bad contact caused by multiple plugging, please replace the battery, or raise the battery shrapnel with a screwdriver

Installation diagram:

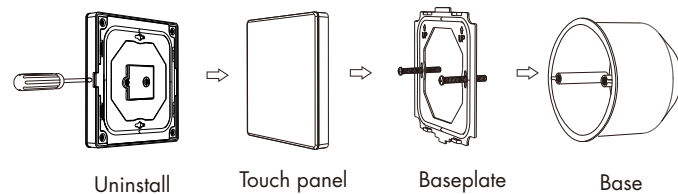

To fix the panel, three options are offered for selection:
 Option 1. fix it on the wall with two screws.
 Option 2. adhere it to the wall with paster.
 Option 3. panel can be adsorbed directly onto metal surfaces.

Match with RF LED Controller (two match ways)

End user can choose the suitable match/delete ways. Two options are offered for selection:

Use the controller's Match key

Match:

Short press match key, immediately press on/off key on the touch panel. The LED indicator fast flash a few times means match is successful.

Delete:

Press and hold match key for 5s to delete all match. The LED indicator fast flash a few times means all matched remotes were deleted.

Use Power Restart

Match:

Switch off the power, then switch on power, repeat again. Immediately short press on/off key 3 times on the touch panel. The light blinks 3 times means match is successful.

Delete:

Switch off the power, then switch on power, repeat again. Immediately short press on/off key 5 times on the touch panel. The light blinks 5 times means all matched remotes were deleted.

Key Function

● TW1 Single color panel

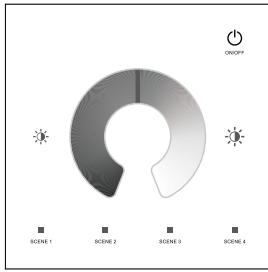

- Turn on/off light.
- Brightness +, 10 levels.
- Brightness -, 10 levels.
- Touch to change brightness.
- Short press recall scene, long press 5s to save the current state into scene 1/2/3/4.

● TW2 Dual color panel

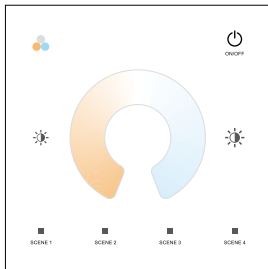

- Turn on/off light.
- Brightness +, 10 levels.
- Brightness -, 10 levels.
- 3 color cycle (warm white, natural white, cold white).
- Touch to change color temperature.
- Short press recall scene, long press 5s to save the current state into scene 1/2/3/4.

● TW4 RGB/RGBW panel

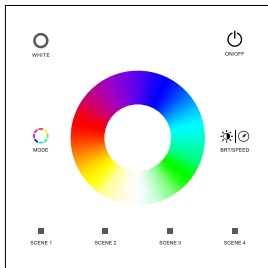

- Turn on/off light.
- For RGB light, short press to get white (RGB mix). For RGBW light, short press to get white (W channel), long press 1-6s adjust W brightness.
- For static color, adjust brightness, short press 10 levels, long press 1-6s for continuous adjustment. For dynamic mode, adjust speed, short press 10 levels, long press 2s get the default speed.
- Short press run next dynamic mode, long press 2s run mode-cycle.
- Touch to change static RGB color.
- Short press recall scene, long press 5s to save the current state into scene 1/2/3/4.

● TW5 RGB+CCT panel

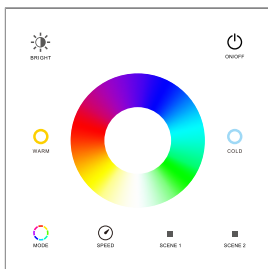

- Turn on/off light.
- Adjust brightness, 10 levels.
- Color temperature -, 11 levels.
- Color temperature +, 11 levels.
- Touch to change static RGB color.
- Short press run next dynamic mode, long press 2s run mode-cycle.
- For dynamic mode, adjust speed, short press 10 levels, long press 2s get the default speed. For static color, adjust saturation, short press 11 levels, long press 1-6s for continuous adjustment.
- Short press recall scene, long press 5s to save the current state into scene 1/2.

Scene locking:

- Scene keys can be set to locked state, cancel long press for 5 seconds to save the scene function (default scene is not locked).
- Short press the panel on/off key, turn on the light first, then turn off the light, immediately long press the panel on/off key for 5 seconds, then immediately long press any one scene key for 5 seconds to set all scene keys to locked state.
- Short press the panel on/off key, turn on the light first, then turn off the light, immediately long press the panel on/off key for 5 seconds, then immediately long press any one scene key for 10 seconds to restore all scene keys to unlocked state.

Safety Information

1. Read all instructions carefully before you begin this installation.
2. When installing battery, pay attention to the battery positive and negative polarity.
A long time without the remote control, remove the battery.
When remote distance becomes smaller and insensitive, replace the battery.
3. Remove and immediately recycle or dispose of used batteries according to local regulations and keep away from children.
Do not dispose of batteries in household trash or incinerate.
4. Do not force discharge, recharge, disassemble, or heat the battery.
5. Stop using the product if the battery compartment is not securely closed.
6. If swallowing occurs seek medical attention immediately.
7. Gently handle remote, beware of falling.
8. For indoor and dry location use only.